

A Manual for Practical Work in
Fashion Studies
Class XII



Central Board of Secondary Education
2, Community Centre, Preet Vihar, Delhi-110 092

© All rights reserved. No part of this publication may be reproduced in any form or by any means, electronic, mechanical, photocopy, recording or otherwise without prior permission of the publisher.

April, 2005

Price : Rs. 40.00

Advisory Committee

- Mr. Ashok Ganguly
Chairman, CBSE
- Mrs. Gauri Kumar
Director General
NIFT, New Delhi
- Mr. G. Balasubramanian
Director (Academic), CBSE

Contributors

- Ms. Vandana Narang
NIFT, New Delhi
- Ms. Monika Gupta
NIFT, New Delhi

Co-ordinator

- Mr. P. Mani
Education Officer (Hum & Lang.), CBSE

Published by:

The Secretary, Central Board of Secondary Education
2, Community Centre, Preet Vihar, Delhi-110 092

Printed at :

Chandu Press, D-97, Shakarpur, New Delhi - 110 092
Ph: 22424396, 22526936

भारत का संविधान

उद्देशिका

हम, भारत के लोग, भारत को एक (सम्पूर्ण प्रभुत्व-संपन्न समाजवादी पंथनिरपेक्ष लोकतंत्रात्मक गणराज्य) बनाने के लिए, तथा उसके समस्त नागरिकों को :

सामाजिक, आर्थिक और राजनैतिक न्याय,
विचार, अभिव्यक्ति, विश्वास, धर्म
और उपासना की स्वतंत्रता,
प्रतिष्ठा और अवसर की समता

प्राप्त कराने के लिए,
तथा उन सब में

व्यक्ति की गरिमा और² (राष्ट्र की एकता और अखण्डता) सुनिश्चित करने वाली बंधुता
बढ़ाने के लिए

दृढ़संकल्प होकर अपनी इस संविधान सभा में आज तारीख 26 नवम्बर, 1949 ई. को एतद्वारा इस संविधान को अंगीकृत, अधिनियमित और आत्मार्पित करते हैं।

- 1 संविधान (बयालीसवां संशोधन) अधिनियम, 1976 की धारा 2 द्वारा (3.1.1977 से) "प्रभुत्व-संपन्न लोकतंत्रात्मक गणराज्य" के स्थान पर प्रतिस्थापित।
- 2 संविधान (बयालीसवां संशोधन) अधिनियम, 1976 की धारा 2 द्वारा (3.1.1977 से) "राष्ट्र की एकता" के स्थान पर प्रतिस्थापित।

भाग 4 क

मूल कर्तव्य

51 क. मूल कर्तव्य – भारत के प्रत्येक नागरिक का यह कर्तव्य होगा कि वह –

- (क) संविधान का पालन करे और उसके आदर्शों, संस्थाओं, राष्ट्र ध्वज और राष्ट्र गान आदर करे;
- (ख) स्वतंत्रता के लिए हमारे राष्ट्रीय आंदोलन को प्रेरित करने वाले उच्च आदर्शों को हृदय में संजोए रखें और उनका पालन करें;
- (ग) भारत की प्रभुता, एकता और अखंडता की रक्षा करें और उसे अक्षुण्ण रखें;
- (घ) देश की रक्षा करें और आह्वान किए जाने पर राष्ट्र की सेवा करें;
- (ङ.) भारत के सभी लोगों में समरसता और समान भ्रातृत्व की भावना का निर्माण करें जो धर्म, भाषा और प्रदेश या वर्ग पर आधारित सभी भेदभाव से परे हों, ऐसी प्रथाओं का त्याग करें जो स्त्रियों के सम्मान के विरुद्ध हैं;
- (च) हमारी सामाजिक संस्कृति की गौरवशाली परंपरा का महत्व समझें और उसका परिरक्षण करें;
- (छ) प्राकृतिक पर्यावरण की जिसके अंतर्गत वन, झील, नदी, और वन्य जीव हैं, रक्षा करें और उसका संवर्धन करें तथा प्राणि मात्र के प्रति दयाभाव रखें;
- (ज) वैज्ञानिक दृष्टिकोण, मानववाद और ज्ञानार्जन तथा सुधार की भावना का विकास करें;
- (झ) सार्वजनिक संपत्ति को सुरक्षित रखें और हिंसा से दूर रहें;
- (ञ) व्यक्तिगत और सामूहिक गतिविधियों के सभी क्षेत्रों में उत्कर्ष की ओर बढ़ने का सतत प्रयास करें जिससे राष्ट्र निरंतर बढ़ते हुए प्रयत्न और उपलब्धि की नई ऊंचाईयों को छू लें।

THE CONSTITUTION OF INDIA

PREAMBLE

WE, THE PEOPLE OF INDIA, having solemnly resolved to constitute India into a¹(SOVEREIGN SOCIALIST SECULAR DEMOCRATIC REPUBLIC) and to secure to all its citizens :

JUSTICE, social, economic and political;

LIBERTY of thought, expression, belief, faith and worship;

EQUALITY of status and of opportunity; and to promote among them all

FRATERNITY assuring the dignity of the individual and the² (unity and integrity of the Nation);

IN OUR CONSTITUENT ASSEMBLY this twenty-sixth day of November, 1949, do **HEREBY ADOPT, ENACT AND GIVE TO OURSELVES THIS CONSTITUTION.**

- 1 Subs. by the Constitution (Forty-Second Amendment) Act, 1976, sec.2, for "Sovereign Democratic Republic (w.e.f. 3.1.1977)
- 2 Subs. by the Constitution (Forty-Second Amendment) Act, 1976, sec.2, for "unity of the Nation (w.e.f. 3.1.1977)

THE CONSTITUTION OF INDIA

Chapter IV A Fundamental Duties

ARTICLE 51A

Fundamental Duties - It shall be the duty of every citizen of India-

- (a) to abide the Constitution and respect its ideals and institutions, the National Flag and the National Anthem;
- (b) to cherish and follow the noble ideals which inspired our national struggle for freedom;
- (c) to uphold and protect the sovereignty, unity and integrity of India;
- (d) to defend the country and render national service when called upon to do so;
- (e) to promote harmony and the spirit of common brotherhood amongst all the people of India transcending religious, linguistic and regional or sectional diversities; to renounce practices derogatory to the dignity of women;
- (f) to value and preserve the rich heritage of our composite culture;
- (g) to protect and improve the rich natural environment including forests, lakes, rivers, wild life and to have compassion for living creatures;
- (h) to develop the scientific temper, humanism and the spirit of inquiry and reform;
- (i) to safeguard public property and to abjure violence;
- (j) to strive towards excellence in all spheres of individual and collective activity so that the nation constantly rises to higher levels of endeavour and achievement.

Foreword

The Central Board of Secondary Education introduced the subject of Fashion Studies as an independent elective subject at senior school level from the academic session 2004-2005. It has published the learning resource books for classes XI and XII with the active support and help of the National Institute of Fashion Technology, New Delhi. The present publication is a Manual for the Practical Work in Fashion Studies for class XII and it covers the practical component that has 30% weightage in the Board's Examination.

The manual gives simple practical tasks/projects in Pattern Making and Basics of Garment Making. Fashion Studies is basically a concept and skill-based subject requiring the students to plan, visualize and execute a number of designs to produce garments. Hence the practical component is of great importance in this subject. Moreover, students should also be taught to use different tools and equipments that are an integral part of design and garment making.

An attempt has been made to include basic exercises in exploration of patterns and simple garment making. They are aimed at helping the learners acquire the right perception and the elementary skills needed to establish a foothold in the field of fashion design and fashion technology. Meticulous care has been bestowed by the authors on the details of each exercise, providing adequate information by way of introduction, aim, materials and methods, conclusions and references. The manual also includes essential information such as Tool Kit, Standard Dress Form Measurement Chart, Established Procedures for Test Fitting and Sewing Kit. A list of basic materials and equipment needed for the practical work besides a set of safety rules in the Laboratory have also been included. It is expected that each candidate will perform all the 16 exercises given in the manual in class XII and maintain a portfolio for assessment following the procedure outlined in the manual. The viva questions given at the end of some exercises will help the learners develop an insight into the concepts and processes involved. .

The eminent faculty of the National Institute of Fashion Technology, New Delhi have contributed to the development of this material. I express my sincere thanks to Mrs. Gauri Kumar, Director General, NIFT and to the authors, Ms. Vandana Narang and Ms. Monika Gupta from the NIFT faculty. Shri G. Balasubramanian, Director (Academic) and Shri P. Mani, Education Officer (H&L) also deserve a special mention for planning and giving shape to this publication. Suggestions for further improvement of the publication will be most welcome.

ASHOK GANGULY
CHAIRMAN

Lab requirement for a batch of 30 students

Lab size - 35 ft. x 20 ft. (minimum)

AC environment

Item	Nos.
Industrial sewing machines with power (costs at least Rs. 4,500/- each)	30
Pattern Making tables (size 5 ft. x 4 ft. cork top)	8 (4 students/tab)
Dress forms (half) costs Rs. 8000/- each	30 (one per student)
Steam irons @ Rs. 1000/-	4
Ironing boards @ Rs. 500/-	4
Soft boards	All around the wall
Stools	30
White board	1
Black board	1

Approximate cost will be Rs. 5,00,000/-

Selection criteria of school

They should have ability to provide appropriate environment, space, equipment, machinery and maintenance, trained faculty, exclusive library for the course, willingness to upgrade facility and faculty.

CONTENTS

1.	Part A	Pattern Making	1
	Practical 1	Basic Bodice	5
	Practical 2	Necklines	8
	Practical 3	Sleeveless Bodice	10
	Practical 4	Dart Manipulation	11
	Practical 5	Princess line Bodice	14
	Practical 6	Basic Skirt	15
	Practical 7	Skirt Variations	17
	Practical 8	Basic Sleeve	19
	Annexure I	Tool Kit	21
	Annexure II	Standard Dress Form Measurement Chart For Bodice & Skirt	23
	Annexure III	Test fitting	24
2.	Part B —	Basics of Garment Making	25
	Practical 1	Continuous Placket	28
	Practical 2	Simple Shirt Placket	31
	Practical 3	Shirt Placket With Facing	33
	Practical 4	Neckline Facings	36
	Practical 5	Sleeve Attachment	42
	Practical 6	Cuff	44
	Practical 7	Assembly of Bodice	47
	Practical 8	Stitching of Skirt	49
	Annexure	Sewing Kit	51

Part A

Pattern Making

Introduction

Pattern Designing is an extensive subject which covers principles of constructions and techniques in a wider sense rather than style detail in narrow sense. It opens scope for infinite variety of styles both for regular designs and fantasy patterns. Pattern construction can be divided in two parts namely measuring correctly & knowledge of technique with which they are applied. Learning pattern making by trial and error is like learning to play music by ear.

This is a method where in body or dress form measurements are taken for developing a pattern. Following a logical stepwise procedure, the measurements are then converted into a pattern. In other words this system depends on accurate measurements to complete the paper pattern. There are limitless designs, which can be achieved for workable garments. Flat pattern making should be done in conjunction with a dress form so that as the design evolves, proportion and balance in the garment can be checked side by side. It is important to transfer the pattern on to a muslin toile (pronounced as '*twall*') to test the fit, on a dress form or a human figure. Flat pattern cutting is now widely used because of its accuracy of sizing and the speed with which complicated designs are made

Basic preparation

Prior planning and clarity is necessary for the performance of the exercises. Read hand-outs, appropriate lab manuals and textbooks before performing the practical. Follow all precautions and regulations while working in the lab. Listen carefully to any introductory remarks and experimental procedure given by your teacher. Make sure that your working space is clean and organized, and all the required stocks and materials are kept ready. Maintain the discipline in your working area.

Recording Results

Results should be recorded in the recommended record/file neatly and legibly with great care. The record of exercises may be done in the following headings:

1. Introduction/Aim

State precisely the purpose and objectives of the practical in two or three sentences.

2. Materials and methods

The requirements like equipment, materials, etc. should be given here. Besides, methods should also be described along with principles of the techniques used.

3. Sample / Results

The paper pattern corrected after test fitting should be labeled and neatly folded and placed in a transparent envelope and attached here.

Things to be included on a pattern are:-

- Grain line
- Centre Front or Centre Back
- Style number or code number of the pattern set may be evolved e.g. **AB 01** here AB identify type of the garment and 01 identify the piece number of complete set. If there are 5 pattern pieces in a garment, the pieces will be numbered as AB 01, AB 02, AB 03, AB 04 and AB 05.
- Pattern piece e.g. skirt front, skirt back, side front etc.
- Size as 32, 34, 36, or S, M, L etc.
- Cutting information - It should be clearly mentioned as to how many pieces are to be cut e.g. Cut 1, Cut 2, Cut on fold.
- Notches - Marks that are needed to help assemble garment sections correctly.
- Directional Fabrics - For fabrics which have designs in one direction such as floral print, stripes, plaid, velvet, fur etc. A symbol "cut one way" or (?) is indicated on the pattern.
- Date - Indicated as a reference point.
- Seam Allowances.

Seam Allowances

The amount of seam allowance required for each seam line may vary depending on the location and end purpose. Generally these are the measurements followed -

- ¼” for sharp curves
- ½” for neckline, armhole, waistline, style line.
- 1” for side seam, centre line, shoulder, plackets.
- 2” for straight hem line.

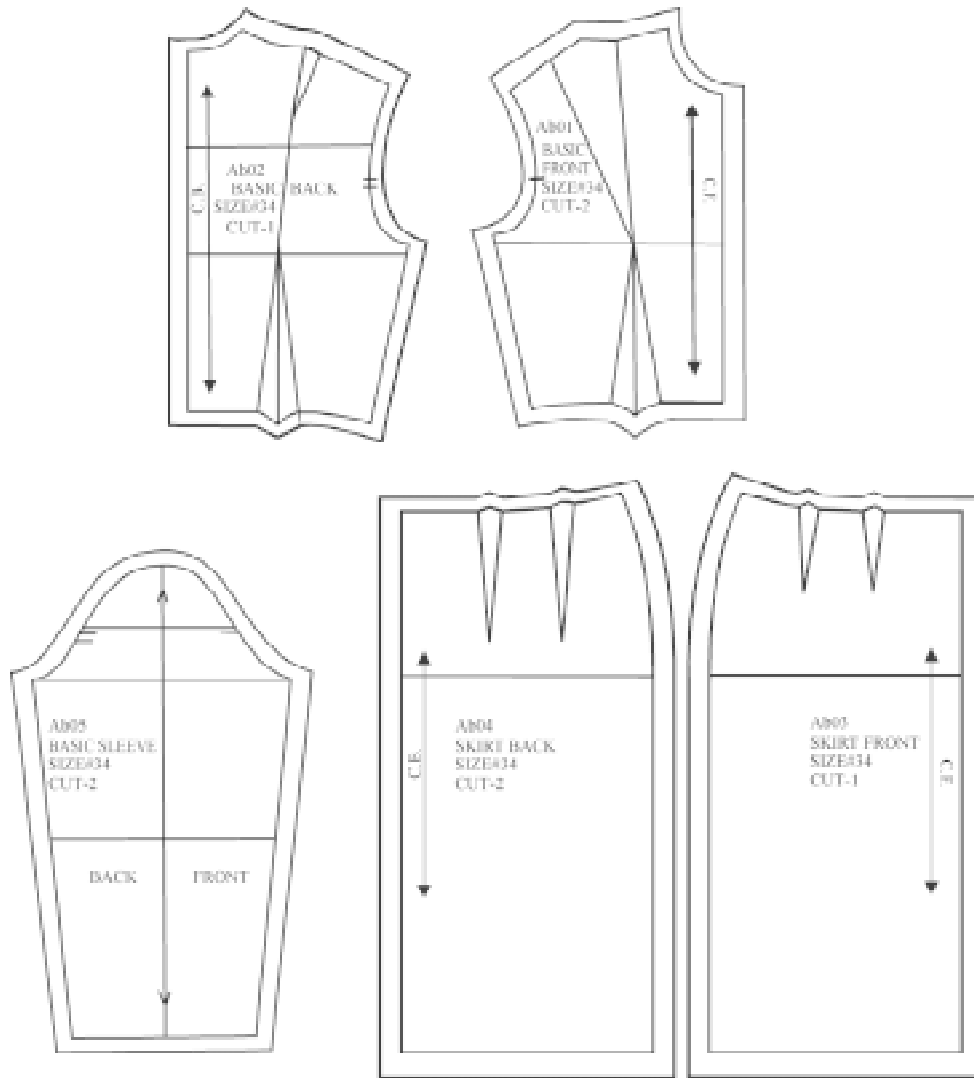

Symbols and abbreviations

Centre Front	-	CF
Centre Back	-	CB
Grain line	-	↕ ↔
Notches	-	∟ ∏ < ∏
Buttons	-	⊙
Button hole	-	⊏
Front	-	F

Back	-	B
Waist line	-	WI
Arm hole	-	Ah
Side Seam	-	SS
Neck line	-	NI
Shoulder	-	Sh
Two way grain line	-	↕
One way grain line	-	↕↑

4. Discussion and Conclusions

Here, the test fits should be interpreted and conclusions be drawn after discussing with your teacher.

5. References

Reading materials that were consulted for the experiment be given as reference (e.g. your lab manual) along with the name of the author and the book, pages referred and year of publication.

Safety rules in the laboratory

- Safety is important to everyone and it is ones responsibility to maintain a safe working place.
- When in doubt, ask the teacher.
- Report any injuries or accidents immediately to the teacher.
- Keep the work station clean with all tools in the tool kit.
- Turn off the iron at the end of the class.
- Always place the iron on the iron pad to avoid burning the ironing board cover.
- When trimming or cutting, put all trimmings & paper in the wastebasket.
- Scissors should be handed to another person with the handles toward the person.
- Never toss or throw scissors or equipment.
- Do not eat or drink in the work area.

Practical 1 BASIC BODICE

Aim

To develop a basic bodice and test fit the same

Principles

Block normally represents the dimensions of a specific form or figure. It has darts to fit to the contours of the body but no other design features. It is a foundation that is used to make the pattern for a design and has no seam allowances.

It is important that the correct block is chosen for the design; this not only saves time during adaptation but can affect the final shape. The basic blocks can be drafted to fit individual figures by using personal measurements instead of the standard measurements listed in the size chart.

Requirements

Pattern paper, muslin and tool kit

Procedure

To develop pattern for basic Bodice for women wear use measurements from the given chart in Annexure II or measure a dress form or a body. Cut a paper, whose length is front length plus 3" and width is half of the bust width plus 4" on fold.

Fold the paper lengthwise and with fold on the left hand side mark a guideline 1" down from the top edge, mark A as illustrated.

A to B = front length

A to C = B to D = front width (+1/2" ease to be added if measured on dress form/body)

Join C to D

Mark D to E = centre front length

CE is front neck depth.

For neck width mark CF = CE - 1/8" Square out lines from these points.

Draw the neckline curve as illustrated, using a French curve.

G = mid point of DE

GH = apex measurement

Square a line from H to I

Mark DJ = Centre front to princess line measurement

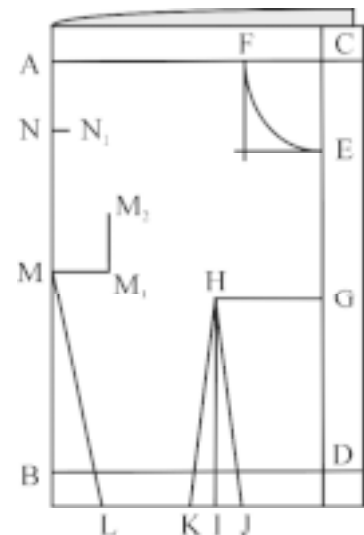

- I K = I J, Join J and K to H
- KL = Front waist line measurement minus DJ (+1/8" ease to be added if measured on dress form/body)
- LM = under arm seam length. Join as illustrated
- M to M1 = M1 to M2 = 2 1/2" square out, as illustrated
- B to N = Shoulder to waistline measurement
- N to N1 = 1/2"

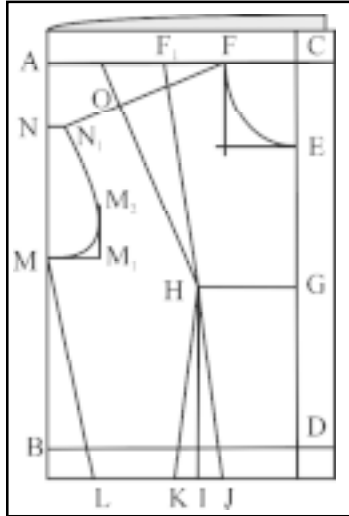

Draw the front armhole curve as illustrated
 Join F to N1
 Mark F to F1 and N1 to O = 1/2 shoulder measurement

Join F1 to H and O to H.
 Trace BD line, L M line and M M1 line on the other half of the paper.

Extend M M1 line on the second half of the paper.
 Mark B to Z = Back width (+1/2" ease to be added if measured on dress form/body)

Z to Y = Centre Back Length

Y to X = C F

X to W = 7/8", draw the back

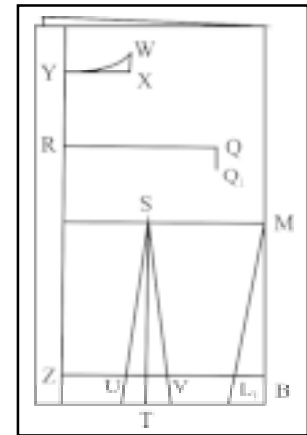

neck line curve as illustrated.

Measure Z to L1 and from this subtract back waistline measurement (+1/8" ease to be added if measured on dress form/body).

The difference should be taken as dart intake at U.

Z to U = Centre back to princess line measurement.

Mark U to V = Dart intake, T is mid point of U and V

Square out from T to S, Join S to U and V.

Mark Y R = 1/4 Centre back length

R Q = Back shoulder blade measurement.

QQ1 = Draw 1" guideline, as illustrated.

Join W to N1 in front

W to P = 1/2 shoulder + 1/8"

P to P1 = 3/4"

P1 to P2 = W to P (1/2 shoulder + 1/8")

Join P to S.

Join P1 to P3 such that P3 is 1" above the shoulder blade line (RQ).

Draw the armhole as illustrated.

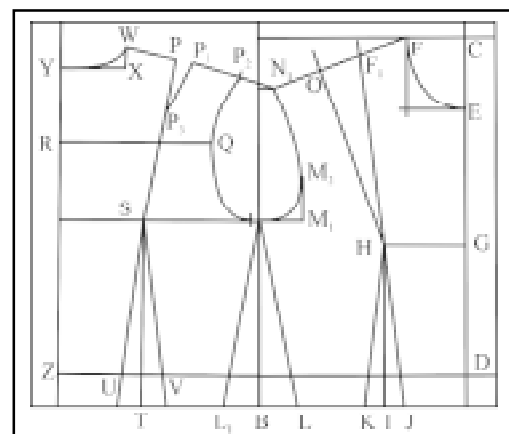

Truing or correcting the lines or darts to conform to body shape or aligning the dart legs and seams.

Front shoulder

Fold the shoulder dart at the apex, matching the two dart legs keeping the folded edge towards the neckline. Join the neck edge with the armhole edge with the straight line at the dart ends. Use a tracing wheel to trace out the folded edge.

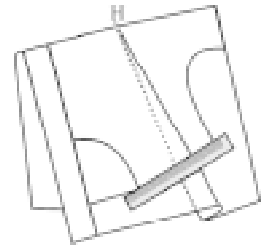

Back shoulder

Fold the shoulder dart matching the two dart legs keeping the folded edge towards the neckline. Draw the shoulder line with the help of the French curve as illustrated, dropping 1/8" on the armhole edge.

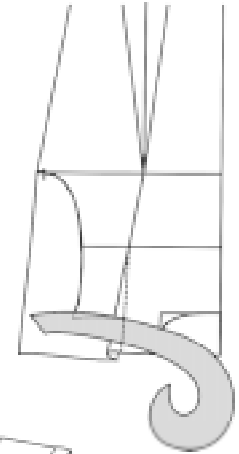

Waist line

Fold both the waist line darts (by matching the dart legs) and also close the side seam, keeping the pattern folded at the apex line. True the waist with help of a French curve, blending the waist line darts and side seam. The side seam should be dropped 1/4" at the side seam, as illustrated.

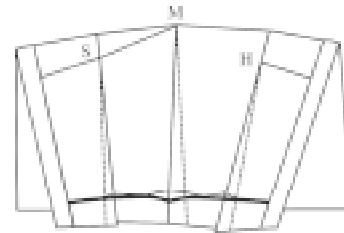

Observations

Test fit the developed Bodice block and check the fit. Make necessary changes if any and make the final pattern.

Viva questions

1. What are the important measurements for development of bodice block?
2. How do you ensure that the bodice is fitting well?

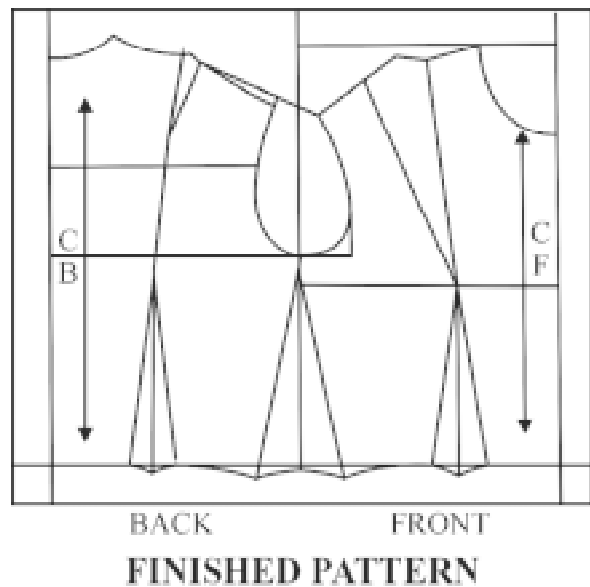

Practical 2 Necklines

Aim

To draft & create neckline variations

Principles

Some important points to be kept in mind for designing necklines are as follows:

1. If a neckline is made wider in the front, the same needs to be done for the back.
2. Try avoiding deeper neckline for both front and back at the same time. In case one decide to keep the neckline deeper in both front and back then an ease of about $\frac{1}{2}$ " needs to be taken out on the centre front neck.
3. The measurement which is taken diagonally should be marked diagonally on the pattern and a measurement taken straight should be marked straight.
4. For curved neckline, always square out $\frac{1}{4}$ " either side at center back and center front and on shoulder level.

Requirements

Pattern paper, muslin and tool kit

Procedure

The **measurement** required for any neckline is the depth of the neck measured from the nape of the neck point to the center front diagonally. (Neckline measurement A)

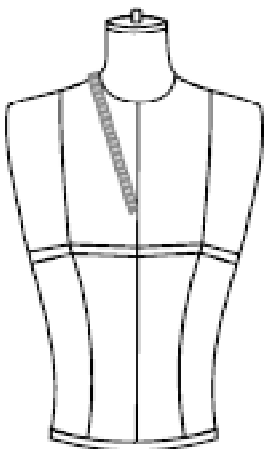

Neckline measurement A

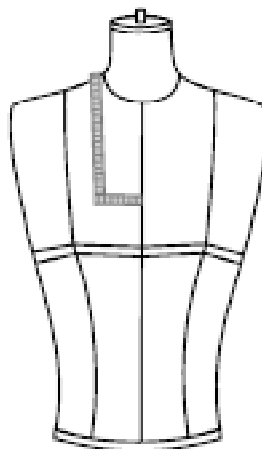

Neckline measurement B

In case of necklines like square, glass neck, sweet heart measure in a straight line on the body for the length and for the width of the neckline at that point to the center front is also measured. (Neckline measurement B)

1. V-Neckline

Trace the neckline of bodice block with dotted line as illustrated.

Extend the centre front line up to A.

Square out lines from A so that it touches the shoulder and neckline intersection at B.

From B, mark BC = 7" down or as required diagonally.

BC is the new V neckline join with a slight curve.

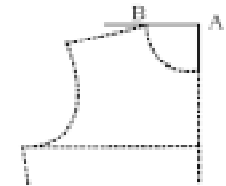
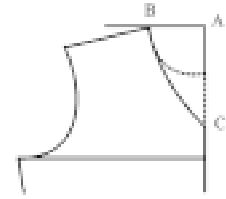

2. Square Neckline

Trace the neckline of bodice block with dotted line as illustrated.

Mark the points AB as for V neckline.

Square down from B to D as the side depth of the neck required or 5½". Square out from D to C on the center front.

This is a basic square neck.

Finish the neckline as desired.

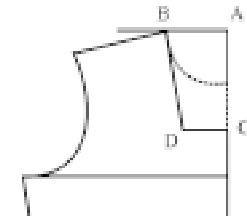
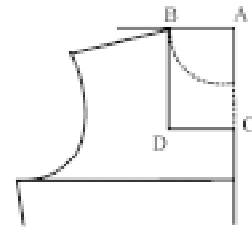

3. Sweet Heart Neckline

Trace the neckline of bodice block with dotted line as illustrated.

Mark the points AB as for V neckline.

From B square down to D for the side depth of the neck required or 5".

Mark E on centre front, where CE = 3½" or as desired.

Join BD and DE with straight lines, for basic sweet heart neck.

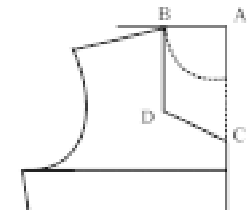

Observations

Test fit the developed neckline and check the fit. Ensure that the neck does not gape. Make necessary changes if any and make the final pattern.

Viva questions

1. What are the important measurements for neckline?
2. How do you ensure that the deep neckline fits well?

Practical 3 Sleeveless Bodice

Aim

To develop a sleeveless bodice and test fit the same.

Principles

In the sleeveless bodice, the armhole should be fitted closer to the body; when the armhole is away from the body the under garments may be visible. Hence it should be finished closer to armpit of the body.

Requirements

Pattern paper, muslin and tool kit

Procedure

For a sleeveless bodice, trace the basic bodice block is used. Change the armhole as follows:

Go up $\frac{1}{2}$ " on the armhole level i.e. E and F and redraw the curves, as illustrated.

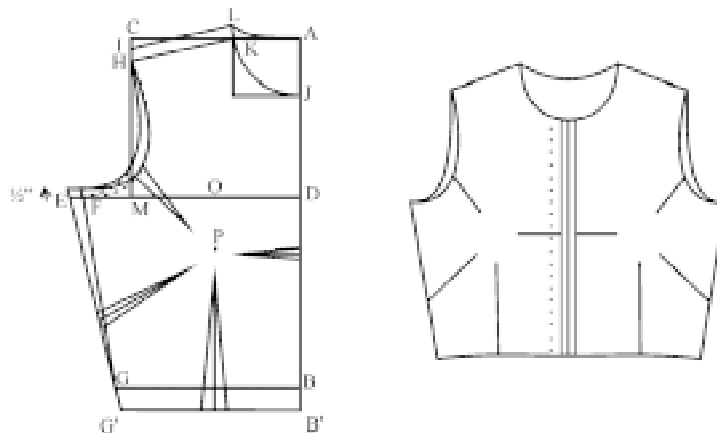

Observations

Ensure that the armhole is closer to the body but does not bite into the armpit.

Viva questions

1. Why does the sleeveless bodice need to cut closer to the body?

Practical 4 Dart Manipulation

Aim

To develop bodices with different dart placement through dart manipulation and test fit the same.

Principles

Dart manipulation is a useful and interesting tool for pattern maker for creating interesting, innovative dart placements and style lines. The change in the position of the darts creates interest in the garments in different dart positions. The same can be magnified by using similar technology on striped fabric where a dart gives a new dimension to the striped pattern. The darts can be stitched as new darts, as style lines, can be converted into tucks, pleats, gathers, yokes, etc. The basic fit of the garment is not altered by these manipulations.

Requirements

Pattern paper, muslin and tool kit

Procedure

SLASH AND SPREAD METHOD

In the slash and spread method, as the name implies the pattern/sloper is slashed or cut on the desired line and as the old dart or excess is closed, the pattern itself spreads on the new position, to create the new design. Some of the new dart positions are illustrated here.

1. Shoulder dart to waist

Take two dart basic block, slash the new dart position i.e. the waist dart. Fold and close the shoulder dart. Trace the new pattern on separate sheet.

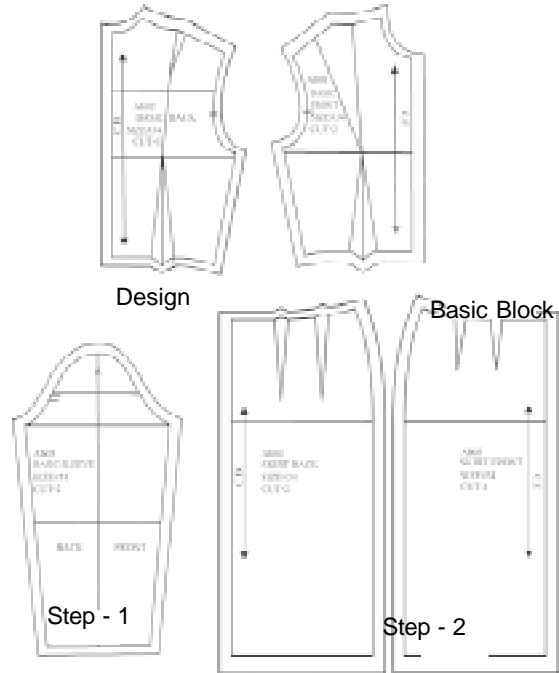

2. Waist dart to centre front

Take one dart bodice block. Slash the new dart position, close the old dart. Trace the pattern on separate sheet.

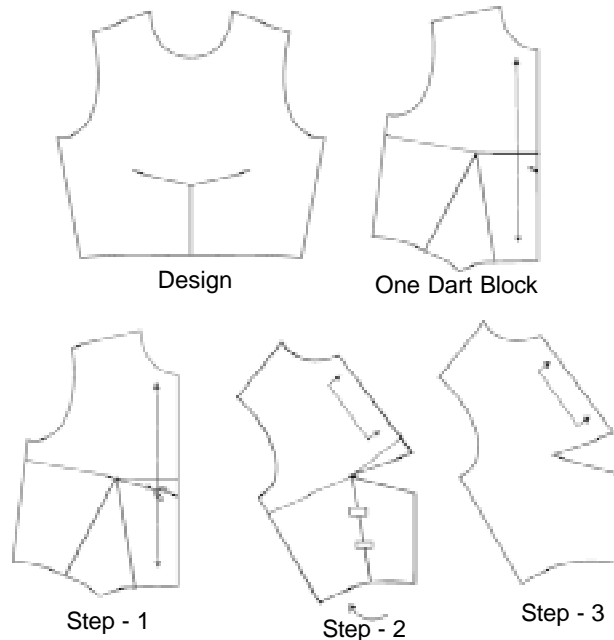

3. Shoulder dart to armhole side seam intersection

Take two dart basic bodice block. Slash the new dart position, close the old dart. Trace the pattern on separate sheet. Shoulder dart to armhole side seam intersection.

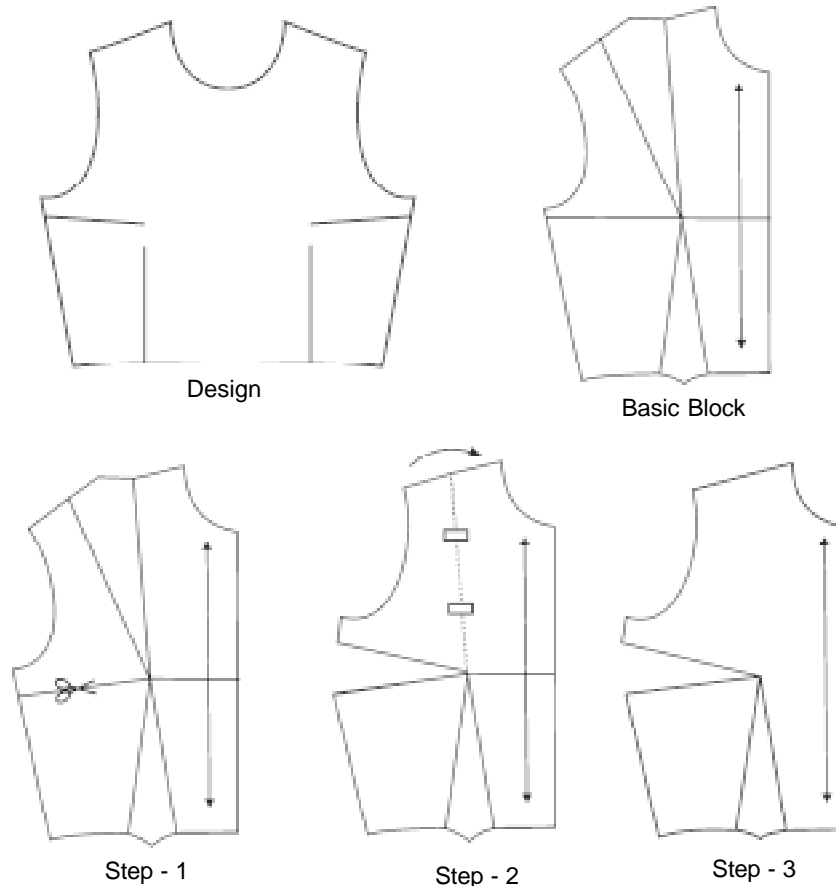

Observations

Test fit the developed dart manipulations and check the fit. Make necessary changes if any.

Viva questions

1. Why is dart manipulation important?
2. What are the things to be kept in mind while using slash and spread method?
3. Does the garment fit as well as the basic block if not what could be the reasons?

Practical 5 Princess line Bodice

Aim

To develop a princess line bodice and test fit the same.

Principles

Princess line is a style line that absorbs dart excess within the stitch lines and hence controls the fit of the garment. The darts are replaced with the seams extending from one side of the pattern to the other.

Requirements

Pattern paper, muslin and tool kit

Procedure

Take a one dart sloper. Shift the dart away from the princess line as desired. Draw the princess line as required. Mark the notches and grain line on both the pieces as illustrated. Slash on the princess line and close the dart. Trace the patterns on another sheet of paper. Ensure that the notches are transferred on the final pattern.

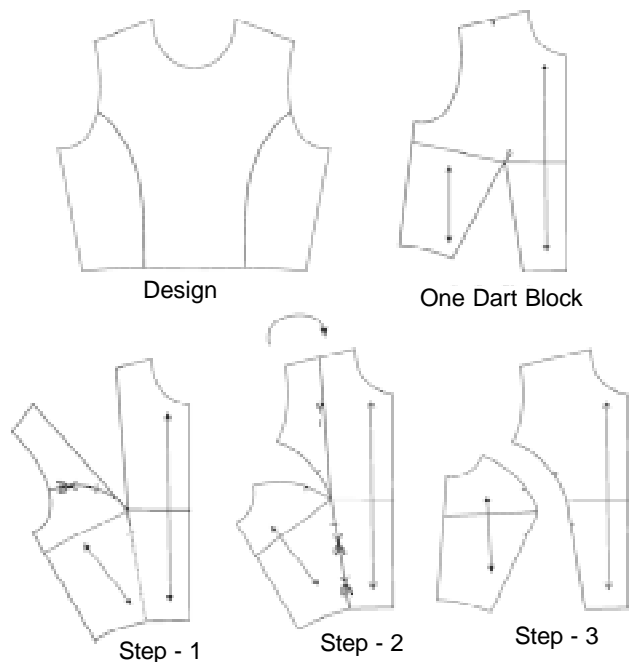

Observations

Test fit the developed princess line bodice and check the fit. Make necessary changes if any and make the final pattern.

Viva questions

1. What are the various positions of princess line?
2. Can a yoke be called a princess line?
3. Can you make a sari blouse with princess line?

Practical 6 Basic Skirt

Aim

To develop a basic skirt and test fit the same

Principles

The basic skirt falls straight downward from the widest part of the hipline. The key to a balanced pattern and garment lies in the accurate placement of the balance line on the dress form and pattern. Any deviation of the balance line between the front and back skirt at the side seam will create fitting problems.

Requirements

Pattern paper, muslin and tool kit

Procedure

To develop pattern for basic skirt for women wear use measurements from the given chart or measure a dress form or a body. Take a paper, whose length is desired length of the skirt plus 3" and width is half of the round hip plus 4".

Make a block A B C D E F, where

A to B = back hip (+1/4" ease to be added if measured on dress form/body)

B to C = front hip (+1/4" ease to be added if measured on dress form/body)

A to D and C to F = Desired length, e.g. 21".

A to G = C to H = 7", hip level

Joint G to H. Mark I at side seam

B to B₁ and B to B₂ = 3/4"

Mark I', 2" above I.

Passing through B₂ and B₁, join I' J and I' K extending it 3/8" above the waistline, as illustrated using hip curve.

A to A' = 1/4"

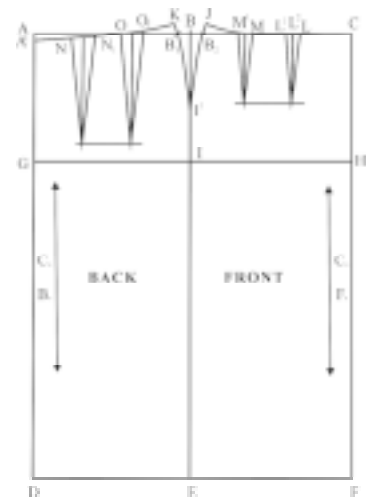

Join J to C, K to A¹ as illustrated, using hip curve.

Measure J to C, K to A¹ and note the measurement on paper, from this measurement subtract the front and back waistline measurement respectively. The difference is the dart intake for both front and back.

Divide this excess into two darts for both front and back.

Draw a guide line parallel to the waist line at a distance of 3½" for front and 5 ½" for the back,

Mark C to L = Centre front to princess line measurement

L to L1 = 1st dart (½ of the total dart intake for front)

L2 is mid point of L, L1.

L1 to M = 1 ½"

M M1, = 2nd dart (½ of the total dart intake)

Mark A¹ N = Centre back to princess line measurement

N to N1 = 1st dart (½ of the total dart intake for the back)

N1 O = 1 ½"

O to O¹ = 2nd dart (½ of the total dart intake)

Find the mid point of all the darts and draw a perpendicular line till the guideline. Join these points to the dart point to form the dart legs.

Trueing

Fold the dart at vanishing point and true the waistline as illustrated raising the waistline by ¼" -½" (when you true the waistline with the help of French curve it automatically goes up) at the side seams. Drop back waist line by 1/8" at centre back.

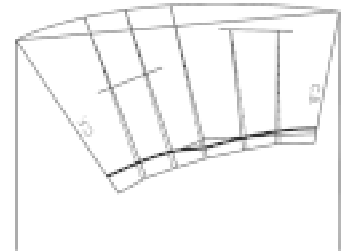

Observations

Test fit the developed skirt block and check the fit. Make necessary changes if any and make the final pattern

Viva questions

1. What are the important measurements for development of skirt block?
2. How do you ensure that the skirt is fitting well?

Practical 7 Skirt variations

Aim

To develop style variations in skirt and test fit the same.

Principles

Variations in skirt can be treated through dart manipulation which you have learnt earlier. It is a useful and interesting method for creating interesting, innovative style lines. The change in the position of the darts creates new styles like an A-line skirt and flared skirt. The suppression of the darts is converted into fullness at the hem. The basic fit of the garment is not altered by these manipulations.

Requirements

Pattern paper, muslin and tool kit

Procedure

1. One dart basic skirt

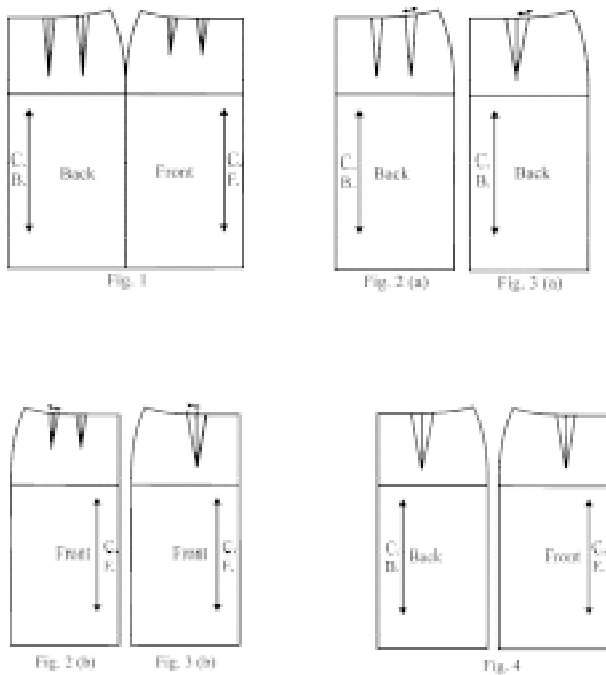

One Dart Basic Skirt

Use a basic skirt sloper that has two darts. Measure the dart towards the side seam and add the measurement to the 1st dart i.e. towards the centre front or back and eliminate the 2nd dart. Note that the length of new waistline dart in the front is 5 ½" same as the back dart length. Find the mid point of the new dart and mark the centre and true the waistline. This method is called measurement method and can only be used in skirts/trousers, as there is no apex in lower half of the body.

2. A-Line

Take a one dart skirt sloper; draw a slash line as illustrated (fig.2). Slash the line and close a part of the waist dart, so that the ease is shifted to the hem. Add 1" - 1 ½" on the side seam at hem line for A-line shape in the skirt as illustrated. Blend till the hip level for both front and back and also blend the hem line.

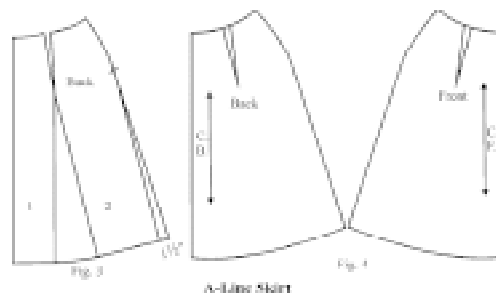
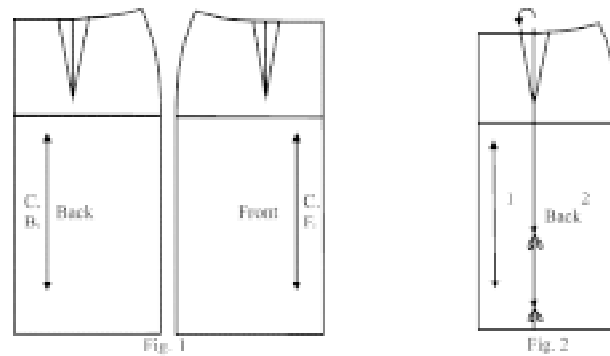

Observations

Test fit the developed skirt variation and check the fit. Make necessary changes if any.

Viva questions

1. How is measurement method used for converting two dart skirt sloper into one dart skirt sloper is ineffective for dart manipulation in bodice and why?
2. Which other skirt design variations are possible through dart manipulation?

Practical 8 Basic sleeve

Aim

To develop a basic sleeve and test fit the same

Principles

The arm is very mobile and the efficient part of the human body as it is capable of moving practically in every direction. When relaxed, it may lie slightly towards the front on the sides. The sleeve is one of the most difficult of the basic patterns to fit. The well balanced sleeve will hang on the relaxed arm with out any visible puckering or stress around the cap.

Requirements

Pattern paper, muslin and tool kit

Procedure

To develop pattern for basic sleeve for women wear use measurements from the given chart. Take a paper, whose length is desired length of the sleeve plus 3" and width is bicep plus 2", fold it lengthwise and place paper with fold towards you.

Mark a guide line 1" away from the edge and label A.

A to B = Cap height

A to C = Full length

B to D = $\frac{1}{2}$ bicep circumference

B to E = $\frac{1}{2}$ BC-1 $\frac{1}{2}$ "

E to F = $\frac{1}{2}$ elbow circumference (that includes ease of $\frac{1}{2}$ " minimum)

Join D to F extending to a line squared from C.

Extend D to G

Find mid point of B D line and A G by folding the paper lengthwise.

On this line mark H to I = $\frac{1}{2}$ cap height + $\frac{3}{4}$ "

Mark A to A1 = $\frac{1}{4}$ " and D to D1=1"

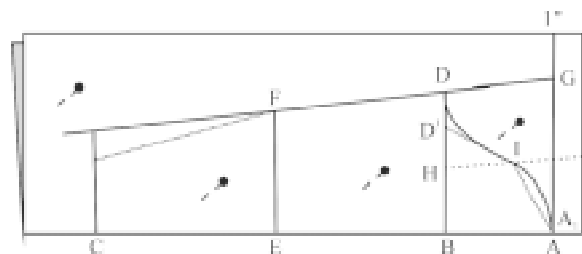

Join A1 to I & I to D1 with dotted lines.

Draw the armhole curve with the help of French curve keeping the guide line in perspective as illustrated in the diagram.

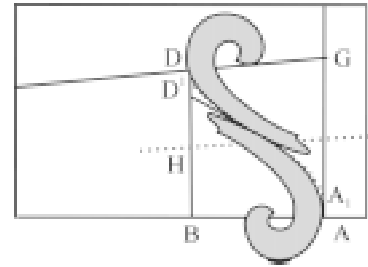

Trace all the lines for front sleeves on the other side of paper. Open the paper.

Find the mid point of A to B by folding the paper and draw the line JK.

Find the mid point M of KL line and on M go in $\frac{1}{4}$ ". Redraw the front curve as illustrated.

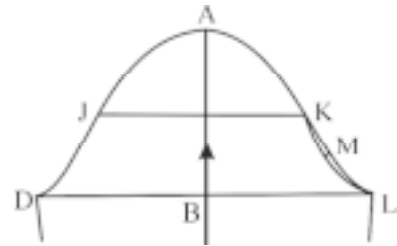

Mark the notches

For front mark one notch = $\frac{1}{2}$ " below point K.

For back mark two notches, one at $\frac{1}{2}$ " below J and next $\frac{1}{2}$ " away from the first notch.

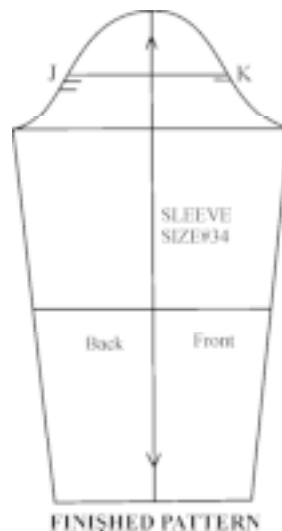

Observations

Test fit the developed sleeve block and check the fit. Make necessary changes if any and make the final pattern.

Viva questions

1. What are the important measurements for development of sleeve block?
2. How do you ensure a well fitting sleeve?

TOOL KIT

- All pins : fine, long, rust proof pins.
- Carbon paper: Coated paper on one side with white or coloured wax, used to transfer marking on fabric or paper.
- Dress form : A standardized duplication of a human torso, cotton padded and canvas covered, set on a movable, light adjustable stand and compressible shoulders and slopers. For taking measurements, develop pattern, fit garment samples, to alter garments, to establish style lines for the garment.
- Grading scale: 2" X 18" transparent straight plastic with grid
- L-square : Plastic or metal ruler with two arms at right angles of varying lengths usually 12" and 24" to square off corners. Establish perpendicular lines, reference points and lines.
- Magnet: a high carbon alloy steel that has a property of attracting iron and steel can be of any shape.
- Measuring tape: Metal tipped narrow, firmly woven double tape of cloth or plastic usually 60" long (150cm) marked with both inches and centimeters.
- Muslin : A plain weave fabric made from bleached or unbleached yarns to test fit and develop patterns.
- Newsprint paper: used for rough drafts.
- Paper shears/scissors: a cutting instrument, ranging in size from 8" to 12", with two sharply pointed straight blades.
- Pattern paper: Strong white paper available in variety of weights and widths.
- Pencil: to mark lines in developing the muslin, pattern or sloper.

- Pin cushion: A small firmly stuffed pillow made in a variety of shapes and sizes.
- Push pins : Drum shaped 1/2" long pin for pivoting and transferring points & to hold pattern pieces and fabric on table.
- Scale: Long ruler 12" / 24" metal or plastic.
- Tailor's shears: A cutting instrument ranging in size from 12" to 16" with two wide blades for cutting fabric and muslin.
- Thick brown paper: Strong brown papers for finished pattern. Used for preliminary patterns drafting and development of the final pattern.
- Tracing wheel : An instrument with small serrated or needle point wheel mounted on one end of a handle for transferring markings from paper patterns on the muslin.
- Transparent tape: A clear plastic narrow continuous stripes with an adhesive surface on one side, available in roll. Used to hold paper pieces and mend tears.

Annexure II

STANDARD DRESS FORM MEASUREMENT CHART FOR BODICE & SKIRT

(in inches)

SIZES	32	34	36	38	40	42	44
FRONT LENGTH	17 ^{1/4}	17 ^{1/2}	17 ^{3/4}	18	18 ^{1/4}	18 ^{1/2}	18 ^{3/4}
WIDTH OF BUST (1" below arm plate)	9 ^{1/2}	10	10 ^{1/2}	11	11 ^{1/2}	12	12 ^{1/2}
CENTRE FRONT LENGTH	14 ^{3/8}	14 ^{1/2}	14 ^{5/8}	14 ^{3/4}	14 ^{7/8}	15	15 ^{1/8}
APEX	3 ^{5/8}	3 ^{3/4}	3 ^{7/8}	4	4 ^{1/8}	4 ^{1/4}	4 ^{3/8}
UNDER ARM SEAM	7 ^{7/8}	8	8 ^{1/8}	8 ^{1/4}	8 ^{3/8}	8 ^{1/2}	8 ^{5/8}
FRONT WAISTLINE	6 ^{3/8}	6 ^{3/4}	7 ^{1/8}	7 ^{1/2}	7 ^{7/8}	8 ^{1/4}	8 ^{5/8}
WAISTLINE TO SHOULDER	14 ^{3/4}	14 ^{7/8}	15	15 ^{1/8}	15 ^{1/4}	15 ^{3/8}	15 ^{1/2}
SHOULDER LENGTH	4 ^{7/8}	5	5 ^{1/8}	5 ^{1/4}	5 ^{3/8}	5 ^{1/2}	5 ^{5/8}
CENTRE FRONT TO PRINCESS LINE	2 ^{5/8}	2 ^{3/4}	2 ^{7/8}	3	3 ^{1/8}	3 ^{1/4}	3 ^{3/8}
WIDTH OF BACK (1" below arm plate)	8 ^{1/2}	9	9 ^{1/2}	10	10 ^{1/2}	11	11 ^{1/26}
CENTRE BACK LENGTH	16 ^{1/2}	16 ^{3/4}	17	17 ^{1/4}	17 ^{1/2}	17 ^{3/4}	18
BACK WAIST LINE	5 ^{5/8}	6	6 ^{3/8}	6 ^{3/4}	7 ^{1/8}	7 ^{1/2}	7 ^{7/8}
shoulder blade	6 ^{7/8}	7	7 ^{1/8}	7 ^{1/4}	7 ^{3/8}	7 ^{1/2}	7 ^{5/8}
centre back to princess line	2 ^{1/2}	2 ^{5/8}	2 ^{3/4}	2 ^{7/8}	3	3 ^{1/8}	3 ^{1/4}
FRONT HIPLINE (7" below waistline)	9 ^{1/8}	9 ^{3/8}	9 ^{5/8}	9 ^{7/8}	10 ^{1/8}	10 ^{3/8}	10 ^{5/8}
BACK HIPLINE (7" below waistline)	9 ^{1/8}	9 ^{3/8}	9 ^{5/8}	9 ^{7/8}	10 ^{1/8}	10 ^{3/8}	10 ^{5/8}

Test fitting

Steps of test fitting are as follows

- Commonly used test material is muslin
- The quickest way to get the effect of the finished garment without actual stitching is to overlap and pin all the seams lines. Pinning gives the same result and information, that one wants without going to the machine. It is so much faster and easier to unpin and then re-pin than to rip stitching and re-stitching.
- Pins should be placed at right angle to the seam line, as in this method there is least amount of strain or pull on the seam, and it does not gape.
- Check the test fit muslin and make correction till fully satisfied.
- Mark the necessary corrections and the same should be transferred on the paper pattern for a final pattern of the garment.

Part B

Basics of Garment Making

Introduction

This course is continuation with that of course in class XIth. The advanced skills are required for converting fabrics into a stitched garment, with value addition are covered in this year. Emphasis is on how to finish the openings and on assembling of complete garment.

Basic Preparation

Prior planning and clarity is necessary for the performance of the exercises. Read hand-outs, appropriate lab manuals and textbooks before performing the practical. Follow all precautions and regulations while working in the lab. Listen carefully to any introductory remarks and experimental procedure given by your teacher. Make sure that your working space is clean and organized, and all the required stocks and materials are kept ready. Maintain the discipline in your working area.

Recording Practical Results

Practical results should be recorded in the recommended record/file neatly and legibly with great care. The record of exercises may be done in the following headings:

1 Introduction/Aim

State precisely the purpose and objectives of the experiment in two or three sentences.

2. Materials and methods

The requirements like equipment, materials, etc. should be given here. Besides, methods should also be described along with principles of the techniques used.

3. Sample / Results

The sample should be attached here.

4. Discussion and Conclusions

Here, the results should be interpreted and conclusions be drawn.

5. References

Reading materials that were consulted for the experiment be given as reference (e.g. your lab manual) along with the name of the author and the book, pages referred and year of publication.

Safety rules in the laboratory

- Safety rules to be observed while working on the machine: Safety is important to everyone and it is ones responsibility to maintain a safe working place.
- When operating the machine, do not be careless.
- Always inspect the machine before starting the work. Be sure it is clean and threaded correctly, with no loose threads on the pulley belt and all guards in place.
- When in doubt, ask the teacher.
- Report any injuries or accidents immediately to the teacher.
- Wipe up any oil spilled on the floor immediately to prevent anyone from slipping.
- Operate machines only with permission.
- When sewing on a power machine, wear low shoes and close-fitting clothing. Avoid loose-fitting sleeves, sweaters, jewellery, ties and ribbons when operating the machine. If your hair is long, tie it at the back.
- Do not tilt your chair forward or backward while operating the machine.
- Use both hands to raise and lower the machine head.
- Always keep your head above the table.
- Keep your feet off the treadle when you are not operating the machine.
- Keep your feet off the treadle when you are setting or threading the needle.
- Turn the motor off when you are not stitching.
- Turn the motor off before cleaning, oiling or adjusting the machine.
- Turn the motor off before removing or replacing the pulley belt and run the machine out. Wait until all motion has stopped.
- Turn the motor off in case of an emergency or when in doubt.

- Turn the motor off before unplugging the machine.
- Do not use your hand to stop and start the hand wheel.
- Use your hand only to set the hand wheel.
- Before operating the machine, close the slide bed cover. When operating the machine, keep your hands, scissors and other sharp objects away from the belt.
- Keep the machine and work station clean with all tools in the side drawer.
- Unplug the machine at the end of the day.
- Know the location of the main power switch, outlets and fuses in case of an emergency.
- Do not remove any safety devices from the machines.
- Turn off the iron at the end of the class.
- Always place the iron on the iron pad to avoid burning the ironing board cover.
- When trimming or cutting, put all trimmings in the wastebasket.
- Scissors should be handed to another person with the handles toward the person.
- Never toss or throw scissors or equipment.
- Do not eat or drink in the work area.
- Keep your machine covered when not in use.

Practical 1 – CONTINUOUS PLACKET

Aim

Stitch a continuous placket sample.

Principles

A placket is a finishing provided to an opening in a garment. Placket should be designed and styled in sufficient length to permit ease and convenience of dressing. Placket openings are used on sleeves, front or back neckline to allow for ease in wearing a garment. Plackets are planned as extension for placement of buttonholes, snaps and other fasteners. Some plackets have buttons and buttonholes, others do not. When designed for neckline openings, the placket can end at the neck edge or be extended beyond the neck and become part of the collar. The measurement can vary to create different effects.

The type and length of placket selected depends on:

- Placement of placket.
- Function of placket.
- Style and design of garment.
- Use of garment.
- Type and weight of fabric.
- Care of garment.
- Method of construction.

Continuous placket is easy to make and serves as the basis for a number of variations. It is one piece placket that is widely used on cuffed sleeve openings to permit hand to fit through sleeve circumferences, bloomers, children's' dresses, on skirts and trousers, where zipper application would detract from appeal of the garment and as a neckline opening alternative to other fasteners or closures.

Requirements

Machine & sewing kit (as given in annexure I)

Pre Lab Preparation

Student should be familiar with the safety rules. Cut the pattern piece for length of the piece take double the length of the finished placket opening and add 1" extra. (The 1" extra length of the binding strip is for emergency only. If measurements are accurate and the placket is properly made, this amount should be cut off after the binding is stitched in place.) The width of the piece will be twice the width of finished placket facing (which is usually ½" for 1 side) plus two times seam allowances (which usually is ¼")

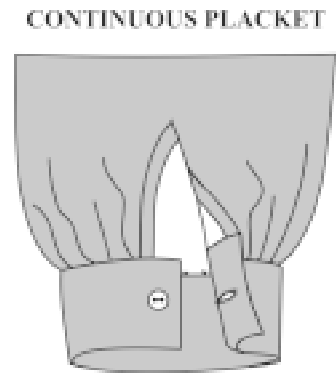
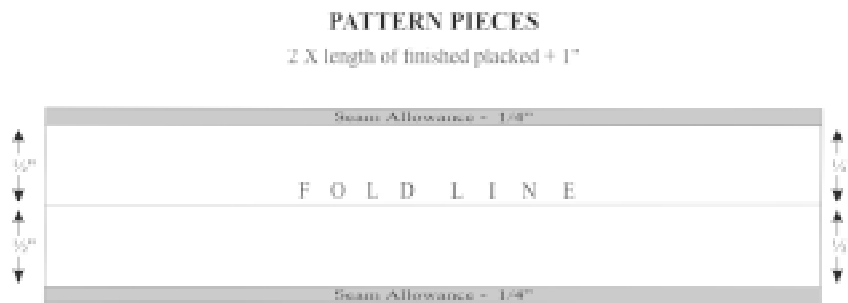

Procedure

1. Place the right side of the placket on the wrong side of the sleeve opening and start stitching near the edge leaving a distance of ¼". As you come in the center of the placket, maintain ¼" seam allowance of placket piece and reduce the allowance of the garment piece. Take care so that no pleat formation takes place at this point.

CONTINUOUS SHIRT PLACKET

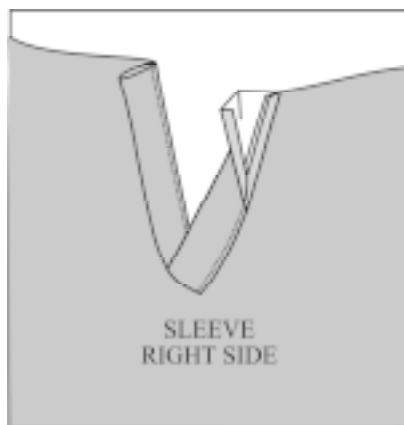
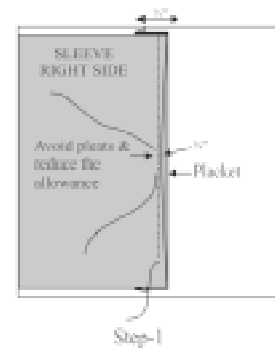

2. Fold the allowance (other side) of the placket and place it on first stitching line. Then stitch in place. From right side of the sleeve. Take care that stitching at the back should be same i.e. if it is on top, it should be maintained on top throughout and if it is in ditch then maintain it throughout. In good quality plackets, this seam is on top at the back.

Step-2

3. From wrong side of the sleeve, stitch both the upper and under of the placket, two to three times diagonally (at 45°) near end. This is known as Bar Tack.

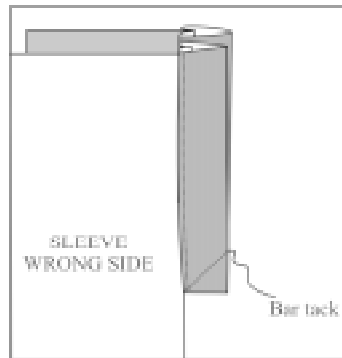

Step-3

Observations

The placket should be finished neatly and close properly on top of each other. The buttons should not gape open especially near the bust.

Viva Questions

1. Where all is this placket used?
2. What is the importance of bar –tack?

Practical 2 - SIMPLE SHIRT PLACKET

Aim

Stitch a simple shirt placket sample.

Principles

A Simple shirt placket is an extension placket where buttons and buttonholes are placed on the facing which is created by extending the center front on both sides.

Requirements

Machine & sewing kit (as given in annexure I)

Pre Lab Preparation

Pattern pieces required are two one for upper part and other for the under part.

Upper Part

Trace the bodice till centre front line. Mark the extension; which is taken as half the button + 1 cm i.e. Radius of the button + 1 cm = extension. Or it is taken as the diameter of the button. Other wise a standard measurement of $\frac{1}{2}$ " or $\frac{3}{4}$ " is taken for men's shirts.

The line of extension is the fold line. After this a standard facing of $1\frac{1}{2}$ " is made, an allowance of $\frac{1}{4}$ " is then taken. Turn the allowance towards wrong side of the facing. Then turn fold line towards wrong side of the garment piece. (If facing has to be aligned to the selvedge when placed on fabric then no seam allowances is taken). Cut out the pattern.

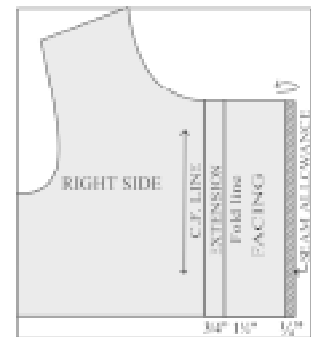

Under Part

Flip the pattern horizontally, trace it. Under part is made in the same way as you make the over part but the difference being the facing, which is 1". Otherwise stitching line of under part will be visible on the front of the placket.

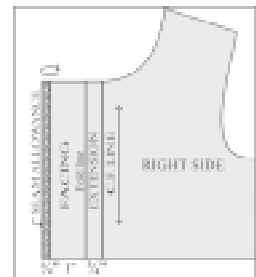

Procedure

Upper Part

1. Trace the pattern on the fabric and mark the position of the lines.
2. Turn the allowance towards the wrong side of the fabric. Turn the facing also in the same way from fold line i.e. towards wrong side of fabric.
3. From wrong side machine on the edge of facing as illustrated.

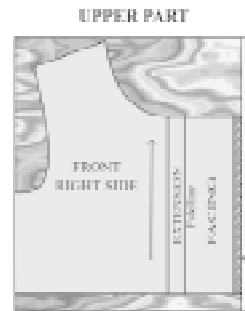

Step-1

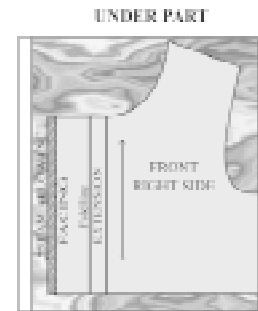

Step-1



Step-2

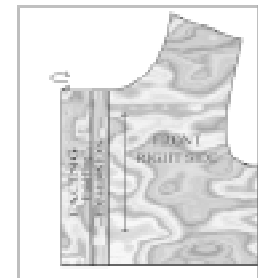

Step-2



Step-3

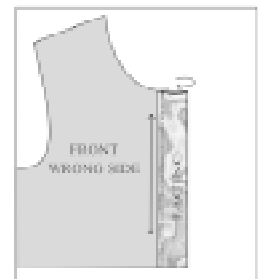

Step-3

Under Part

1. Trace the pattern on the fabric and mark the position of all lines.
2. Turn the allowance towards wrong side of the fabric. In same way turn the facing also.
2. From wrong side machine on the edge of the facing as illustrated.

Observations

The placket should be finished neatly and close properly on top of each other. The buttons should not gape open especially near the bust.

Viva questions

1. The width of the placket is dependent on what factors?
2. Where all apart from shirt this placket is used?

Practical 3 - SHIRT PLACKET WITH FACING

Aim

Stitch a sample of shirt placket with facing.

Principles

The shirt band/the strip on the right side of shirt front in which the buttonholes are made, eliminates the need for facing. An extended self-facing is used on the left front. The finished shirt band is 1½” wide but construction techniques vary depending on the fabric and style of the shirt.

Requirements

Machine & sewing kit (as given in annexure I)

Pre Lab Preparation

Under Part

Trace the bodice and make extension of ¾” which is half of finished placket. Then give an allowance of ¼”.

Facing

A straight strip of the length same as placket opening is taken, mark ¼” seam allowance on one side and ½” seam allowance on the other side.

Under Part

Flip and trace the other half of bodice and mark extension of ¾” and facing of 1” then mark the seam allowance of ¼”.

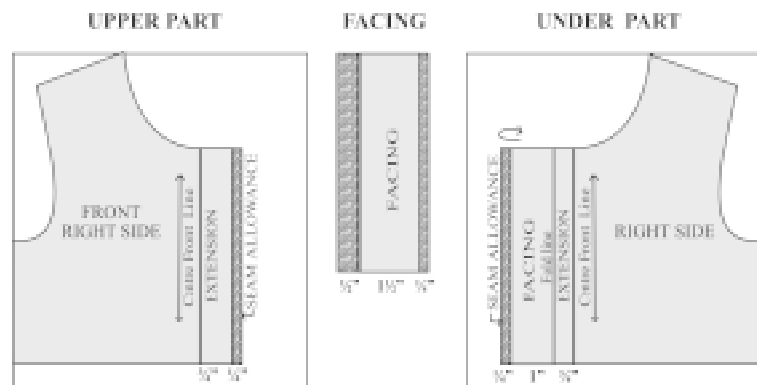

Procedure

Upper Part

1. Place right side of the facing over wrong side of garment piece and then stitch leaving the $\frac{1}{4}$ " allowance near edge.
2. From right side of the fabric, turn facing towards right side. Press the seam allowance ($\frac{1}{2}$ ") of facing towards wrong side of facing. Iron in place.
3. Leave allowance of $\frac{1}{4}$ " from both the sides and stitch in place from right side.

Under Part

Trace the pattern for under part on the fabric. Fold the seam allowance of the facing towards the wrong side of the fabric. Again turn this facing towards the wrong side of the fabric, stitch in place. (For diagram refer steps of construction for under part of simple shirt placket.)

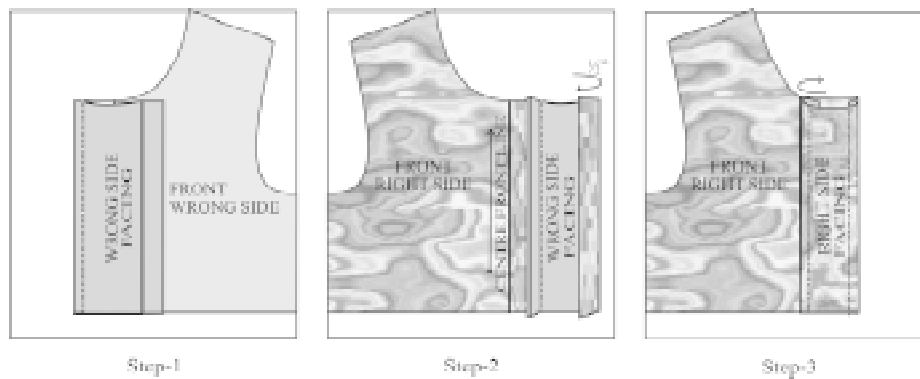

Placement of Buttons

The button extension is equal to the width of the button. As a general rule the neckline of the front bodice is lowered by $\frac{1}{4}$ " at the centre front for comfort, whenever a basic neckline is required. The first buttonhole is placed on center front, down from neckline an amount equal to the width of the button. This ensures that the button will not extend into the neck. Placement of the last button hole depends on the need or the requirement of the garment. The rest of the button holes are marked on the even division between the first and the last. It is a good

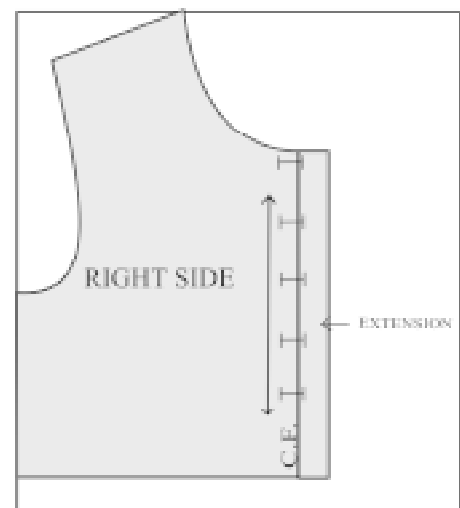

idea to place a button close to the apex or bust point this ensures that the garment does not gape open at centre front due to movement which may cause a pull on the bust.

The size of the button hole equals the width of the button plus 1/8" for the button to go in easily. The button hole is marked so that width of the button is on the garment side of the centre front and extra 1/8" is on the extension.

Observations

The placket should be finished neatly and close properly on top of each other. The buttons should not gape open specially near the bust.

Viva questions

1. Give common uses of this placket.
2. What distance from the neck edge should the first button be placed on the placket?

Practical 4 - Neckline Facings

Aim

Stitch a sample each of extended facing, bias facing and shaped facing.

Principles

A facing is the fabric used to finish raw edges of a garment at such locations as neck, armhole and front and back opening. There are three categories of facings: Shaped facings, extended facings and bias facings.

A facing is shaped to fit the edge it will finish either during cutting or just before application. A “shaped facing” is cut out, using a pattern, to the same shape and on the same grain as the edge it will finish. A “bias facing” is a strip of fabric cut on the bias so that it can be shaped to match the curve of the edge it will be applied to. After a facing is attached to the garments edge, it is turned to the inside of the garment and should not show on the outside.

In order to reduce bulk, both shaped and bias facings can be cut from a fabric lighter in weight than the garment fabric. Because the extended facing is cut as one with the garment, garment and facing fabric are always the same but some times may vary according to the design.

NECKLINES

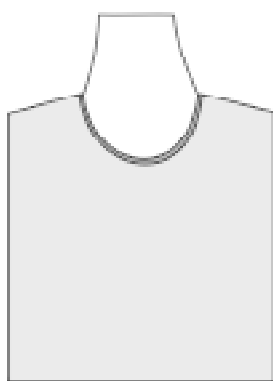

BIAS BINDING

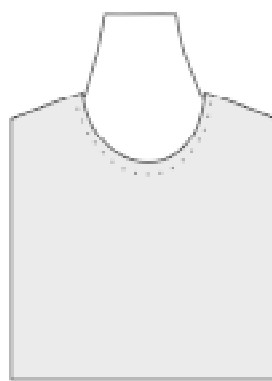

BIAS FACING

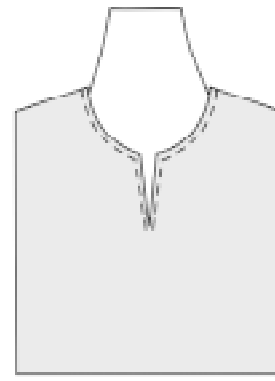

SHAPED FACING

Requirements

Machine & sewing kit (as given in annexure I)

Pre Lab Preparation

Bias Strip

Bias strip is prepared as a strip of matching or contrasting fabric. Bias for binding, piping and tubing is a true bias and is defined as the diagonal line established by a 45° degree angle, intersecting length and cross grain of a square. The bias of the fabric offers the maximum stretch, flexibility, and elasticity needed to conform to a curved edge.

Preparation of Bias Strip

- First of all find the true bias of the fabric by folding fabric with lengthwise grain parallel to the crosswise grain. The fold edge is the true bias.
- After locating true bias, draw the width and the desired number of strips needed for desired length of bias and then cut it.
- Many times the bias stripes are not long enough to complete a continuous sewing step. Adequate number of strips must be joined before starting to sew bias binding or facing. Now place the cut out bias strips at right angles, right side facing right side.
- Stitch bias strips with a ¼" seam allowance at angles.
- Continue to join bias strips as needed for the desired length. Press all seams open and snip extended points.

Once the strip is ready it can be applied on the neckline

Procedure

A. Neckline Finished with Bias Binding/Extended Facing

A standard bias strip is 1 to ½ inch wide.

Steps of construction

- Place the garment on sewing table wrong side up. Now place the bias strip on the garment with right side facing wrong side (of garment), matching both the raw edges.
- Stitch with a ¼" seam allowance.
- Fold the bias strip over ¼" and press down.

- Fold bias binding over along stitch line and press down.
- Fold bias strip over Wrong Side of garment just covering first stitch line.
- Slip stitch along the edge of bias binding.

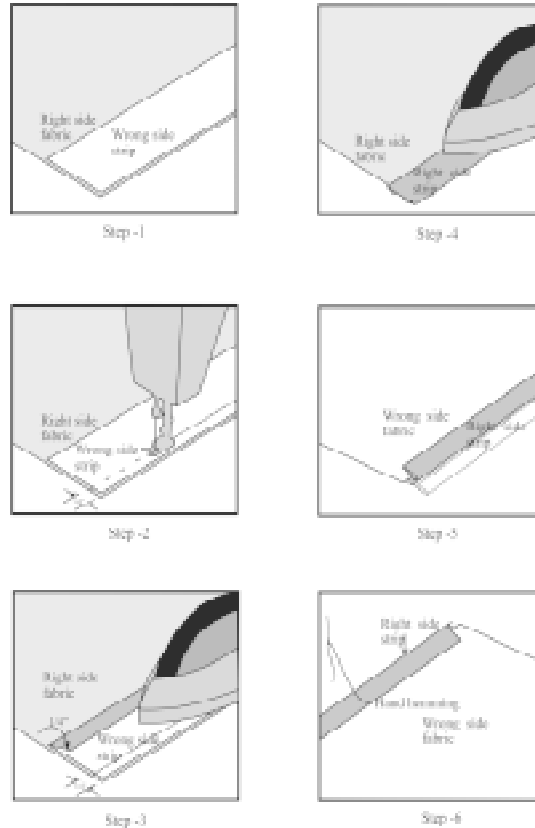

B. Neckline Finished With Bias Facing

A bias facing is a strip of fabric cut on the bias, which is attached to the garment neckline so that it can be shaped to match the curve of the edge it will be applied to. After a facing is attached to the garment, it is turned to the inside of the garment and should not show on the outside i.e. right side of the garment. The finished width of bias facing should not be more than $\frac{1}{2}$ ".

Steps of Construction

- Face right side of bias strip to the right side of the garment neckline. When applying the binding, fold back the starting end $\frac{1}{2}$ " and align the fold with the garment seam line. Pin binding in place and stitch to within 3" of starting point.
- Trim away excess binding at this end to $\frac{1}{2}$ " beyond fold of starting end. Lap this end over the beginning fold and stitch the rest of the way across, through all thicknesses.

When the binding will be turned, the end folded first will be on top; stitch or slip stitch it with the other end.

- Clip the curved seam allowance.
- Open the facing away from the garment press all seam allowances towards the facing. To keep facing from rolling to outside of garments, the seam should be under stitched with facing and seam allowance extended away from garment. Stitch from right side close to neck seam line, through facing and seam allowance.
- Turn the other edge of the facing towards its Wrong Side. Press and slip stitch.

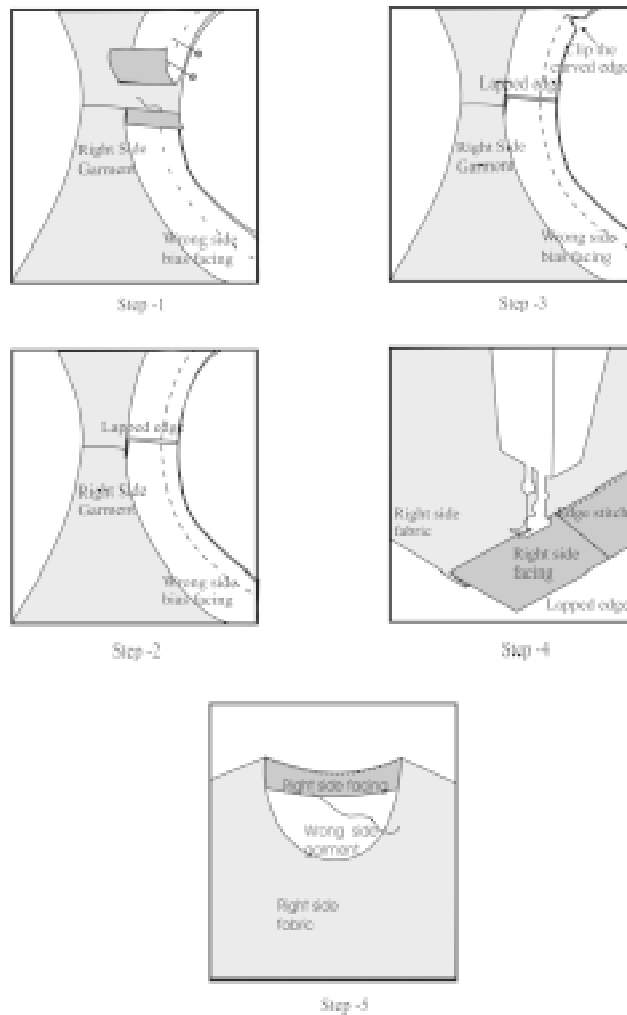

C. Slit Neckline With Shaped Facing

A neck line shape which is finished with shaped facing i.e. instead of finishing raw edges of fabric at neckline with bias strip as used earlier, it is finished with a facing which is of the same shape as the neckline.

Steps of Construction

- Interface the Wrong Side of the facing of both front back.
- With Right Side together and the markings matched seam the front facing sections to the back facing sections at shoulders. Press seam flat as stitched then open.
- Keeping seam allowances open, tailor edge finish the facing by turning under 1/8" Press. Stitch close to folded edge.
- Right Side together, matching, notches, markings and seam lines, pin facing to neck and machine.
- Trim diagonally across cross seam allowances at shoulders. Clip curved seams also slash the opening at front neckline and clip the corners.
- Place seam Wrong Side up, using the tip of the iron press seam open.
- Turn facing to inside of garment, allowing seam line to roll inside slightly, now top stitch at a distance of 1/4".

Steps of Construction

Preparation of facing

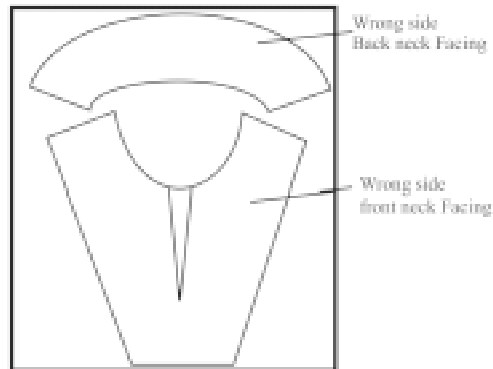

Step-1

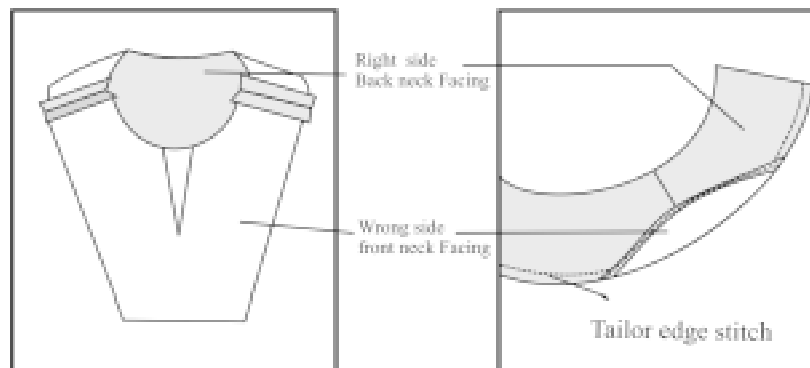

Step-2

Step-3

Steps of Construction

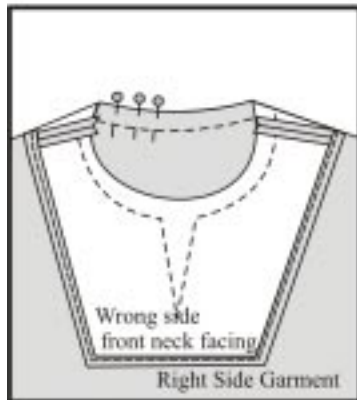

Step -4

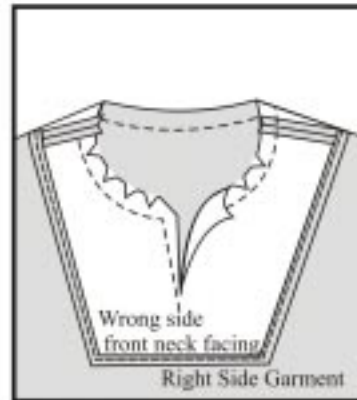

Step -5

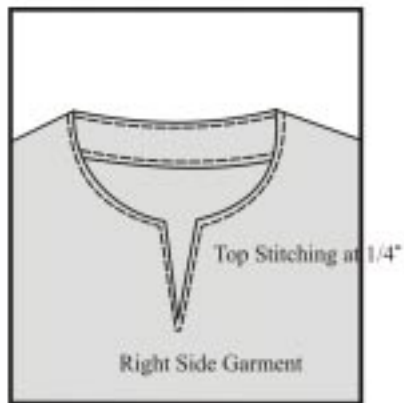

Step -6

Observations

The ready piping should not be more than $\frac{1}{4}$ " wide and should look neat and straight with no extra twist or pucker.

Viva questions

1. What is true bias and what are its characteristics?
2. What is facing? Where all it is used?

Practical 5 - Sleeve Attachment

Aim

Stitch a sample of sleeve attachment.

Principles

Set-in sleeves are the most widely used type. As the name implies this sleeve is actually set into the armhole of edge, or cap, can be slightly rounded or fully gathered, the length long or short, the bottom tapered, flared or gathered to the armhole can also vary from standard round armhole in sleeves are designed with a slightly rounded, cap ideally they should fall in a smooth curve from the shoulder edge with no dimpling or puckering. To achieve this, the sleeve cap curvature must be carefully eased into the armhole.

To achieve success with any garment, whether it is sleeveless or made with sleeves, it is wise to observe several principles.

- Check garment and sleeve fit and alter the pattern accordingly.
- Carefully and accurately transfer all sleeve and armhole markings to the fashion fabric.
- Use proper pressing techniques during construction.
- Whenever possible, finish the lower edge of the sleeve before attaching it to the garment.

Requirements

Machine & sewing kit (as given in annexure I)

Pre Lab Preparation

Trace the pattern on muslin with appropriate seam allowances marked and cut.

Procedure

- Place two rows of stitching on the cap of the sleeve 1/8" away from the stitching line. The distance between the two lines will be 1/4". Take care that the stitch size should be more than the usual one. Leave long threads at the starting & end of both the seams.
- Face right side to the right side and stitch at the side of the sleeve.

- Pull the threads and insert the sleeve inside the armhole of the bodice. Adjust the size of the sleeve cap by pulling and releasing the thread. Put pins in position.
- Stitch the sleeve to the armhole.

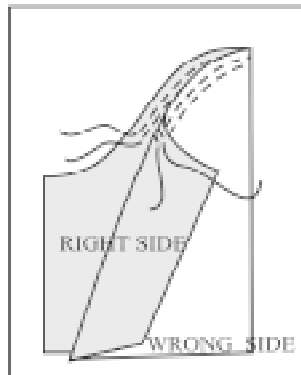

STEP-1

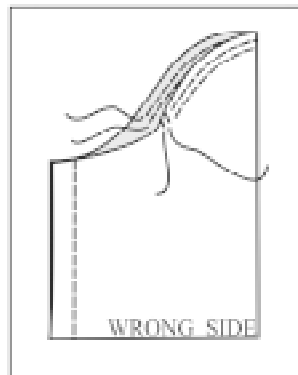

STEP-2

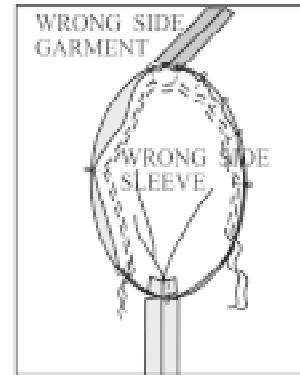

STEP-3

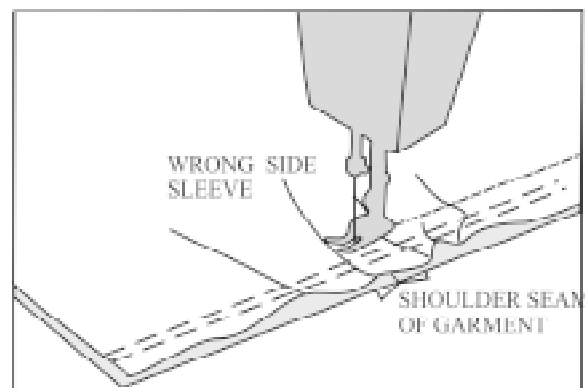

STEP-4

Observations

Test fit the stitched sleeve on the dress form and check to ensure that centre of the sleeve aligns with the side seam of the dress form.

Viva questions

1. What is special about a set-in sleeve?
2. Why do you need ease on the upper half of the sleeve cap?

Practical 6 – CUFF

Aim

Stitch a sample of cuff - one piece straight.

Principles

Cuffs actually consist of a cuff and a facing section, which may be cut all in one or may be in two pieces. Before starting cuff application, apply the type of placket, which is required for that particular sleeve and then complete the underarm sleeve seam. Prepare pleats or gathers at sleeve edge if any. Note the placement of the cuff end to placket edge.

Requirements

Machine & sewing kit (as given in annexure I)

Pre Lab Preparation

Cut the following pieces-

1. One piece of upper and under cuff each.
2. Micro-dot interfacing for cuff.
3. Sleeve on which cuff will be applied along with sleeve placket.

Procedure

1. Fuse the wrong side of the upper cuff to interfacing, which can come to fold line or can be extended half inch beyond the fold line.
2. Turn the seam allowance of the upper cuff to the wrong side of the cuff and give top stitch at a distance of $\frac{1}{4}$ " or $\frac{3}{4}$ " as required.
3. Fold along fold line right side facing each other and pin the two ends from wrong side, stitch at a distance of half inch from both the sides. Chop off extra seam allowance near the edges.
4. Turn inside out and pull the corners.
5. Face wrong side of the sleeve to the right side of the under cuff, machine stitch in place.

6. Insert all the seam allowance into the cuff. Start machining at the edge, from the right side of the upper cuff on to the right side of the sleeve.
7. Optional top stitch at a distance of ¼” all around the cuff edges.

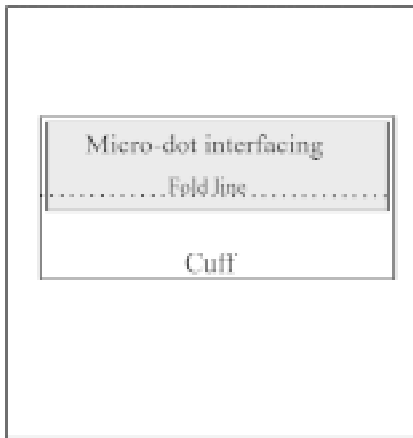

Step-1

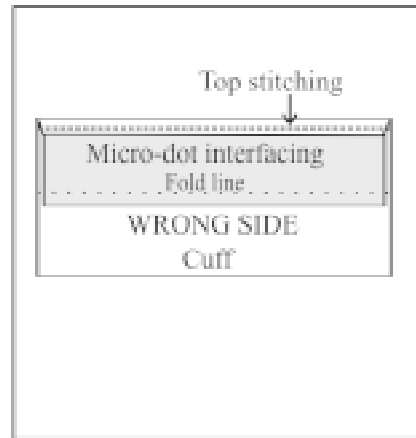

Step-2

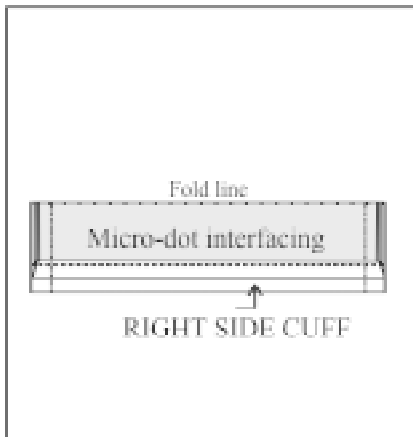

Step-3

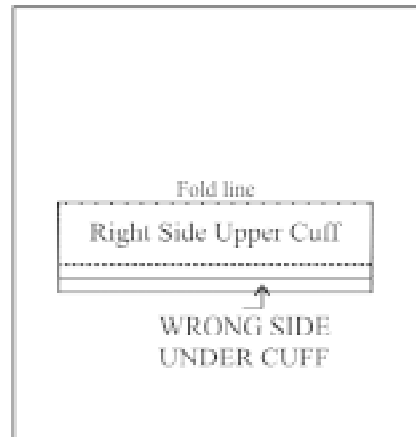

Step-4

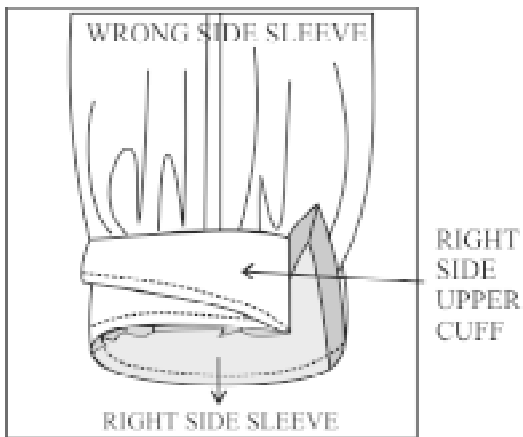

Step-5

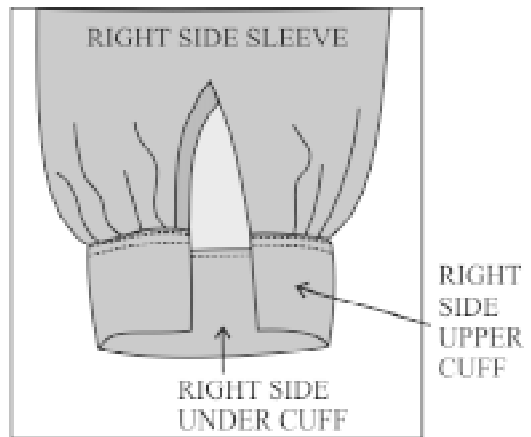

Step-6

Observations

The cuff should be neatly finished and buttons should and close properly on one another.

Viva questions

1. Where is one piece straight cuff used?
2. What are the advantages and disadvantages of using one piece straight cuff.

Practical 7 - Assembly of Bodice

Aim

Stitching of a ladies shirt / blouse.

Requirements

Machine & sewing kit (as given in annexure I)

Pre Lab Preparation

Select an appropriate design. Cut a pattern and trace on suitable fabric.

Before starting to stitch ensure that all the pieces are there, for this make a check list of the pieces for the garment.

Press flat all the pieces for a neat and good finish of the finish.

A beginner should prepare a sequence of the procedure to be followed so as to ensure that there are minimal errors and least amount of corrections.

All the curved seam edges should be stay stitched to avoid stretching.

Pin baste all the seam lines before stitching. This ensures neater seams.

Procedure

1. Stitch the darts of both the front and back bodice if any, as demonstrated previously.
2. Stitch the shoulder seam with a suitable finish (it can be plain seam/ French seam)
3. Finish the placket opening if any, suitably. (as has been given in the earlier chapter)
4. Finish the neckline suitably with facing / collar/ piping as required.
5. Stitch the side seam with a suitable finish (it can be plain seam/ French seam/ Flat fell/ Hong Kong bound)
6. Finish the armhole with facing/ piping/ sleeve suitably. (The attachment of sleeve should be done as explained in the book.)
7. Finish the waistline with hand hem/ machine finish suitably.

Observations

The garment should be neatly finished from inside and outside. The seams should not pucker. All the seams used should be appropriate according to the requirement.

Viva questions

1. What all preparation is required before starting to stitch a shirt?
2. What openings are you using for your design and why?

Practical 8 - Stitching of Skirt

Aim

Stitch a skirt.

Requirements

Machine & sewing kit (as given in annexure I)

Pre Lab Preparation

Select an appropriate design. Cut a pattern and trace on suitable fabric.

Before starting to stitch ensure that all the pieces are there, for this make a check list of the pieces for the garment.

Press flat all the pieces for a neat and good finish of the finish.

A beginner should prepare a sequence of the procedure to be followed so as to ensure that there are minimal errors and least amount of corrections.

All the curved seam edges should be stay stitched to avoid stretching.

Pin baste all the seamlines before stitching. This ensures neater seams.

Procedure

1. Stitch the darts of both the front and back skirt.
2. Stitch the side seam with a suitable finish (it can be plain seam/ French seam/ Flat fell/ Hong Kong bound)
3. If the skirt has design/features such as pleats, tucks, gathers, etc these should be finished appropriately, for e.g. If the skirt has gathers / pleats the same should be stitched in place before next step.
4. Finish the waistline with waist band/ facing suitably. The waistband is stitched similar to the cuff as explained in the book.
5. Finish the hem with hand hem/ machine finish suitably.

Before applying the waist band/ belt the following things should be completed-

- Stay stitch the waistline edge.
- Stitch the darts.
- Stitch the side seams and press open the seams.

Observations

The garment should be neatly finished from inside and outside. The seams should not pucker. All the seams used should be appropriate according to the requirement.

Viva questions

1. What all preparation is required before starting to stitch a skirt?
2. What is the hem width required for the skirt?

SEWING KIT

All pins : fine, long, rust proof pins.

Magnetic pin holder / pin cushion: to hold pins.

Muslin : to experiment and develop samples.

Push pins : Drum shaped 1/2" long pin, to hold pattern pieces and fabric on table.

Tracing wheel : An instrument with small serrated or needle point wheel mounted on one end of a handle. For transferring markings from paper patterns on the muslin.

Tailor chalk: for marking on fabric.

12" / 24" scale: to mark straight lines to measure.

Measuring tape: Metal tipped narrow, firmly woven double tape of cloth or plastic usually 60" long (150cm) marked with both inches and centimeters.

Grading scale : 2" X 18" transparent straight plastic with grid in inches and fraction of inches (or millimeters) ruler.

Pencil: to mark lines in developing the muslin, pattern or sloper.

L-square : Plastic or metal ruler with two arms at right angles of varying lengths usually 12" and 24", to square off corners.

Carbon paper: Coated paper on one side with white or coloured wax, to transfer marking on fabric or paper.

Transparent tape: to hold paper pieces and mend tears.

Paper shears/scissors: a cutting instrument, ranging in size from 8" to 12", with two sharply pointed straight blades, to cut paper patterns.

Tailor's shears: A cutting instrument ranging in size from 12" to 16" with two wide blades, to cut fabric and muslin.

Magnet: a high carbon alloy steel that has a property of attracting iron and steel can be of any shape, to pick up pins and needles.